

23.08.2018

Modelname / Model name / Nom du mod le / Modellnamn / Nome modello / N zev modelu / Modelnaam /  
 Ime modela / Num ro Modello / Modell neve / Название модели / N zov modelu / Ime modela /  
 Denumire model / Наименование на модела / Nazwa modelu

Type / Tipo / T pus / Тур / Тип / Tip

**-ORLANDO -**

**49**

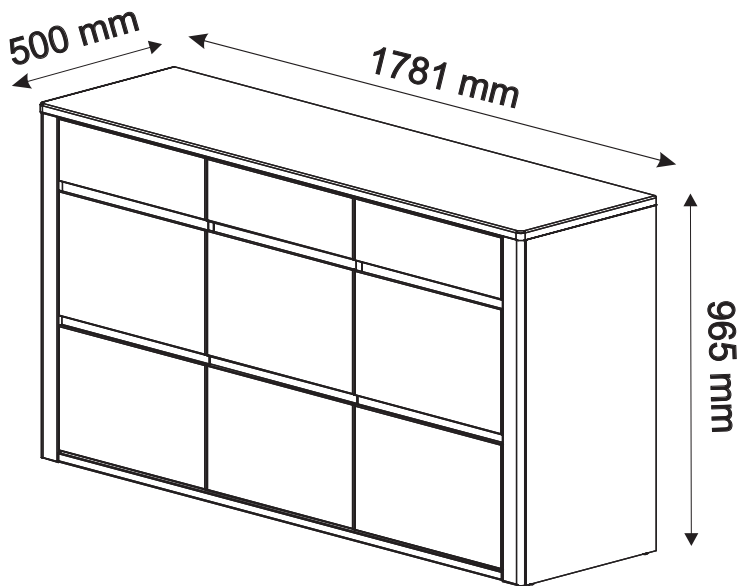

**B1**

000544		x6
001324		x2
�5		
000011		x12
000073		x1
000071		x1
4x45		
000070		x2
000656		x5
006099		x1

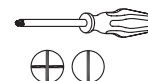
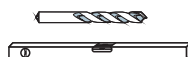
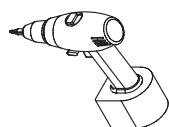
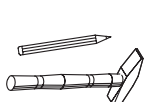
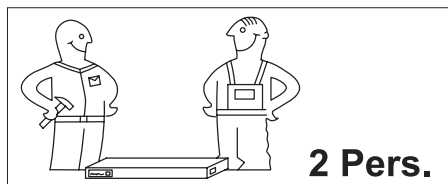
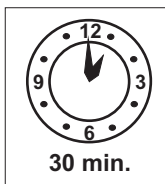
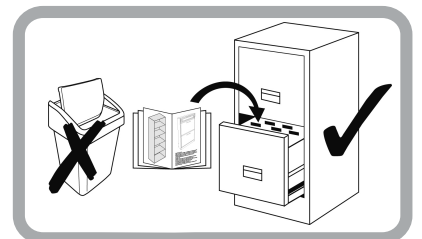

23.08.2018

Modelname / Model name / Nom du modčle / Modellnamn / Nome modello / Název modelu / Modelnaam / Ime modela / Numéro Modello / Modell neve / Название модели / Názov modelu / Ime modela / Denumire model / Наименование на модела / Nazwa modelu

Type / Tipo / Típus / Тур / Тип / Tip

# -ORLANDO -

# 49

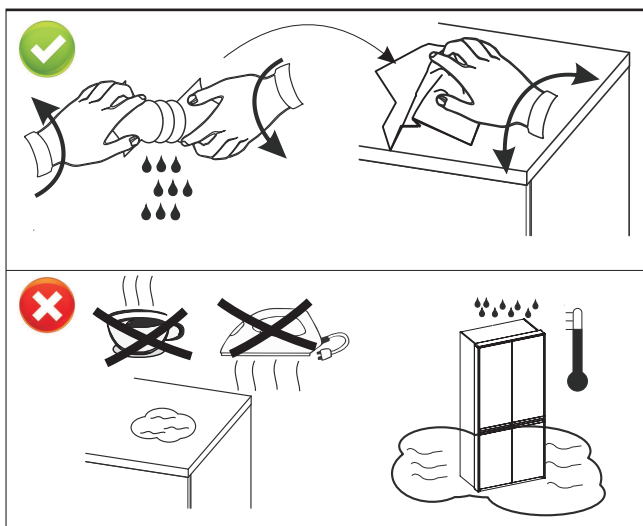
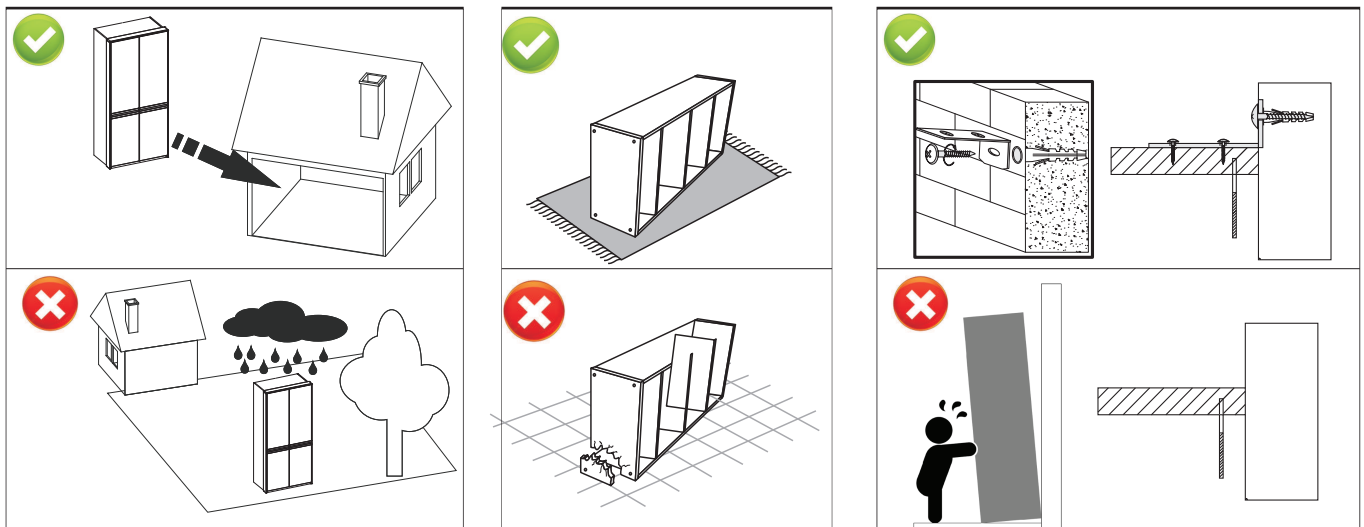
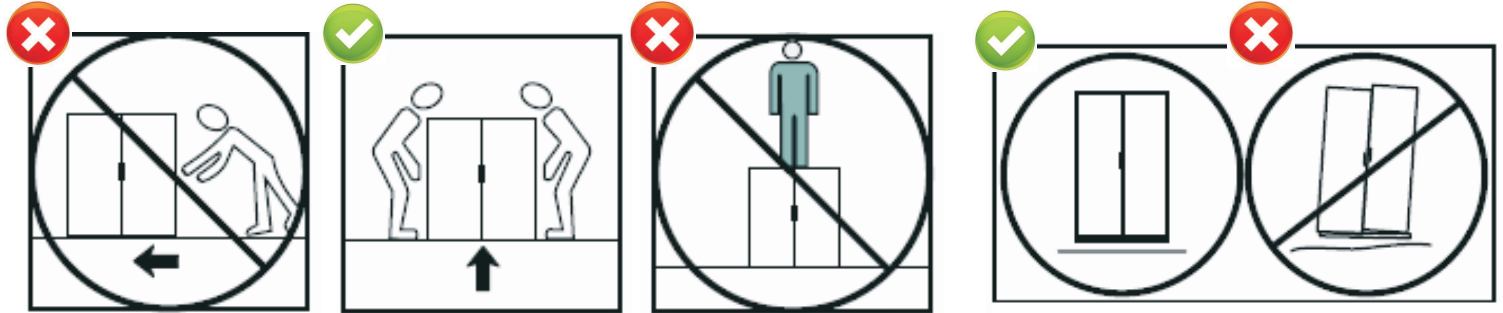

Tel: +48 601 247 625  
 Tel: +48 601 677 210  
 sprzedaz@dekortmeble.pl  
 www.dekortmeble.pl

23.08.2018

Modelname / Model name / Nom du modèle / Modellnamn / Nome modello / Název modelu / Modelnaam /  
 Ime modela / Numéro Modello / Modell neve / Название модели / Názov modelu / Ime modela /  
 Denumire model / Наименование на модела / Nazwa modelu

Type / Tipo / Típus / Тип / Тип / Tip

# -ORLANDO -

# 49

max.







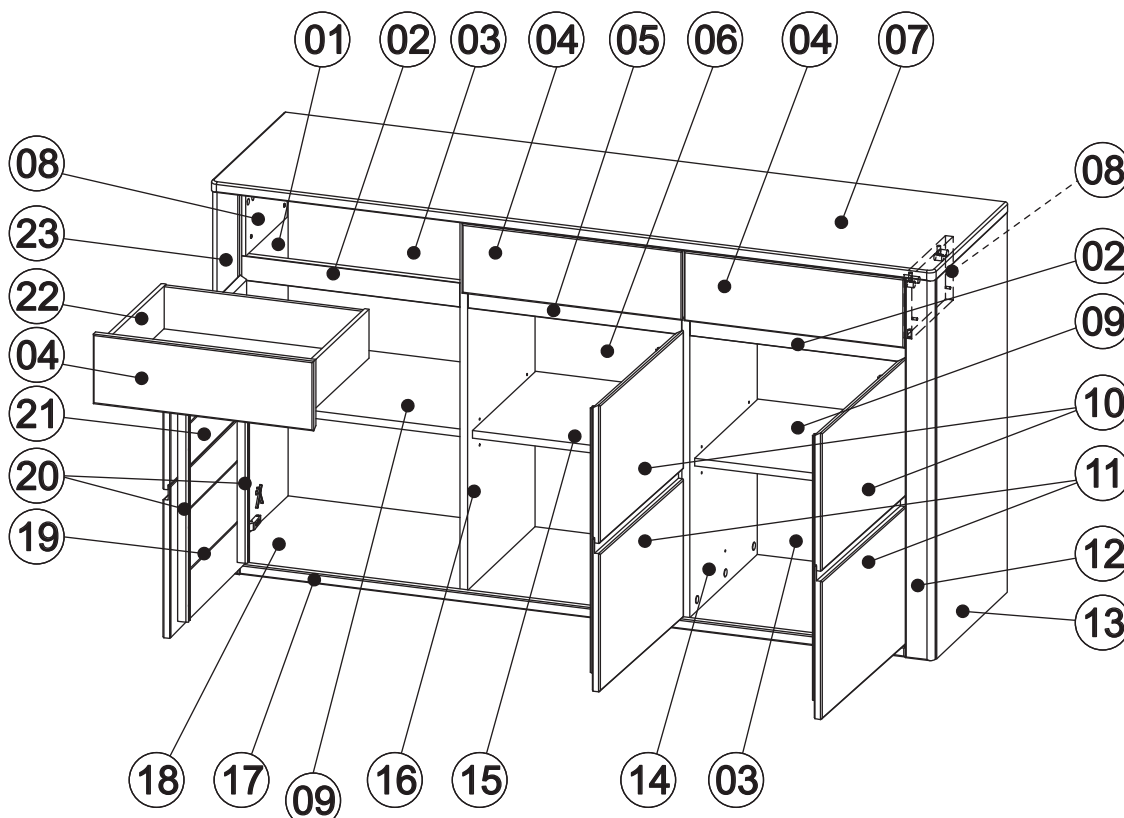

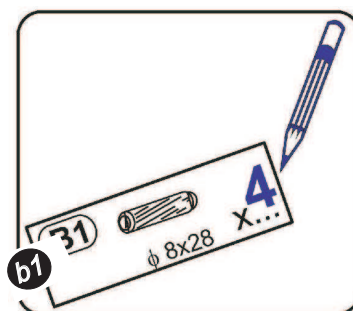
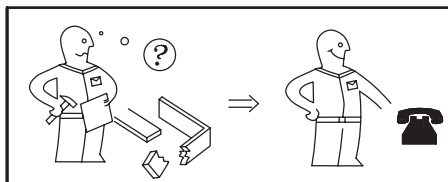
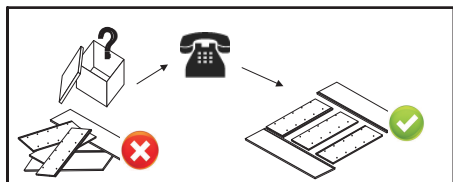

09

15



000007 $\phi 8 \times 28$ X...	000021 3,5x16 X...	000073 X...	000016 3x16 X...	0005380 X...	000396 3,5x13 X...
000200 X...	000222 3,5x12 X...	000071 $\phi 8 \times 40$ 4x45 X...	000013 X...	000015 6,3x13 X...	000006 X...
000010 X...	000223 4x30 X...	000070 3,5x13 X...	000544 X...	000062 3x16 X...	001211 4x40 X...
000011 X...	006151 X...	000180 X...	000656 X...	000443 3,5x35 X...	
000043 X...	006152 X...	001324 $\phi 5$ X...			
006150 X...					



000544		x6
001324		x2
φ5		
000011		x12
000073		x1
000071		x1
4x45		
000070		x2
3,5x13		
000656		x5

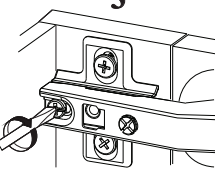
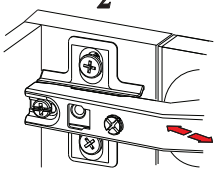
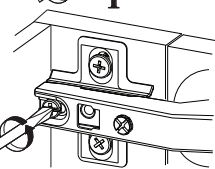
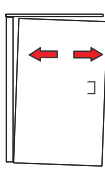
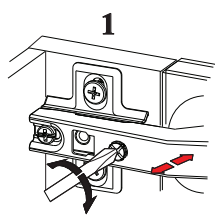
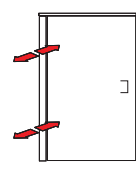
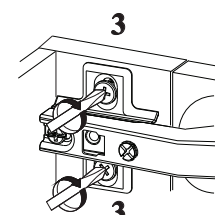
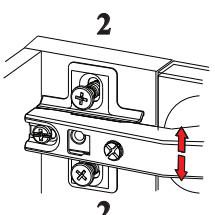
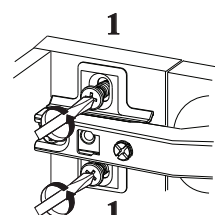
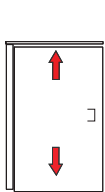
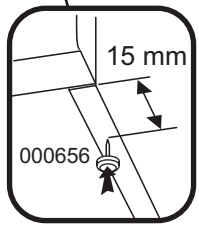
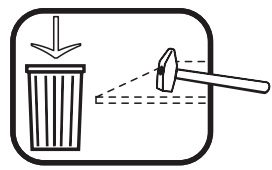
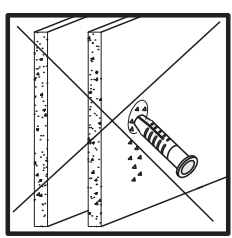
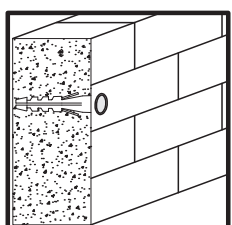
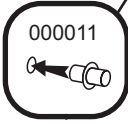
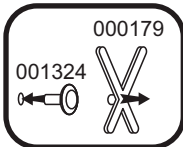
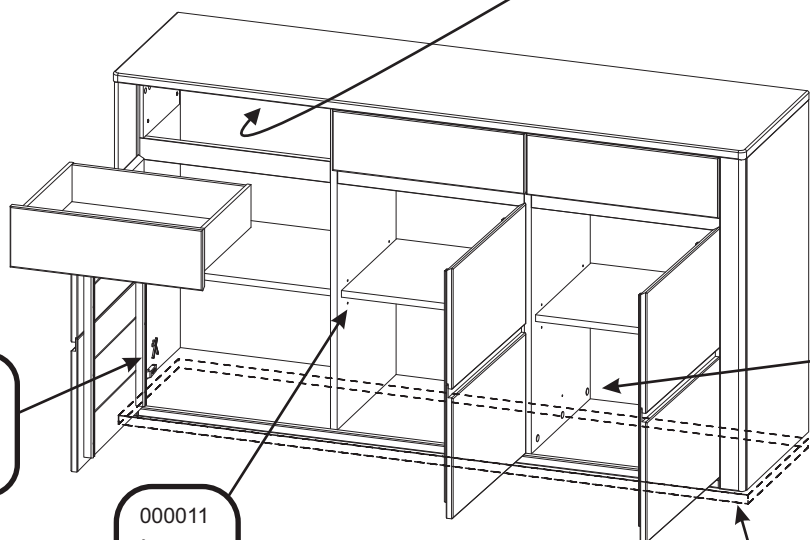
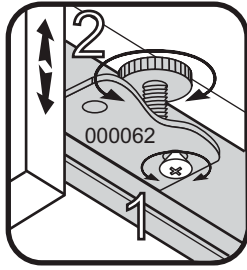
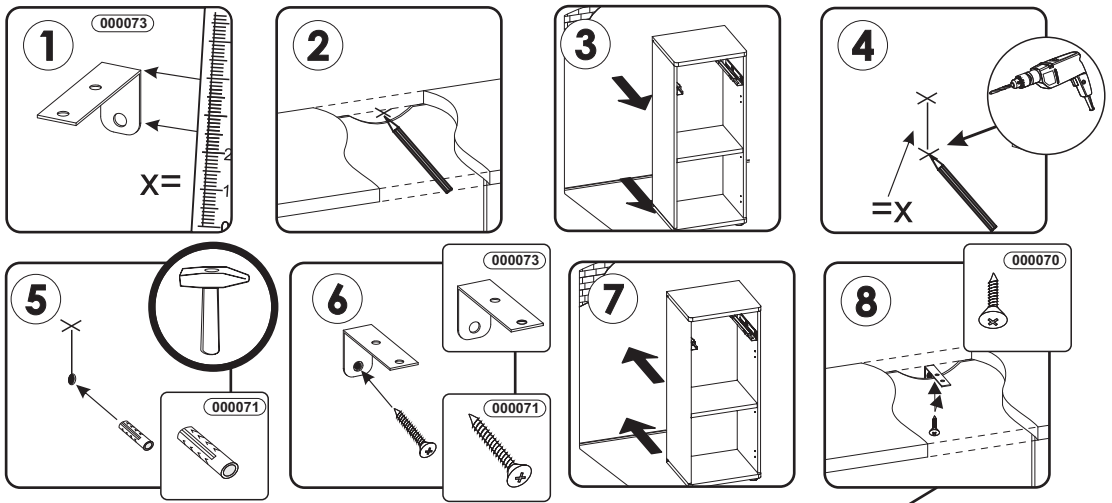

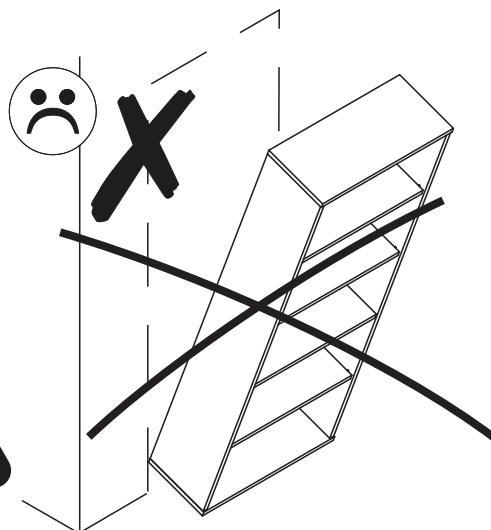
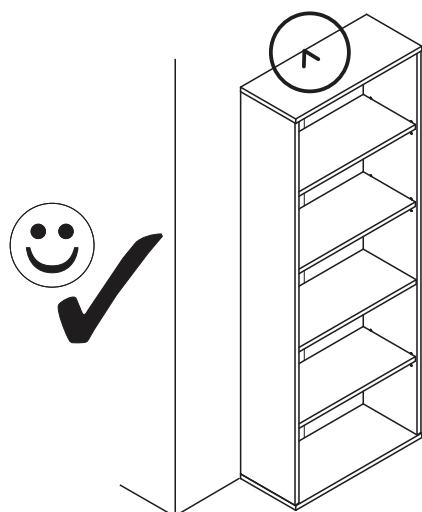

PL.

UWAGA! Mebel należy trwale zamocować do ściany, aby uniknąć ryzyka związanego z przewróceniem się mebla. W paczce znajdują się elementy mocujące odpowiednie wyłącznie do ścian betonowych lub z pełnej cegły. Jeśli Twoja ściana wykonana jest z innego materiału lub nie masz pewności co do budowy tej ściany, skonsultuj się w kwestii montażu ze specjalistą.

RU.

ПРИМЕЧАНИЕ! Эту мебель необходимо всегда прикреплять к стене, чтобы избежать рисков, связанных с переворотом мебели. В пакете находятся крепительные элементы, которые подходят исключительно к бетонным стенам или из целого кирпича. Если стена изготовлена из другого материала или Вы не уверены относительно строения стены, проконсультируйтесь относительно монтажа со специалистом.

I.

ATTENZIONE! Il mobile deve essere permanentemente fissato alla parete per evitare i rischi derivanti da un ribaltamento del mobile. La confezione contiene solo elementi di fissaggio adatti per pareti in calcestruzzo o in laterizio pieno. Se la vostra parete è realizzata in materiale diverso o avete dubbi sulla costruzione della parete, consultare uno specialista per un montaggio corretto.

SLO.

POZOR! Pohišivo trajno pritrđite na steno, da preprečite tveganje, da se prevrne. V paketu so pritrđilni elementi, ki so ustrezni izključno za betonske stene in za stene iz polne opeke. Če je vaša stena izdelana iz drugih materialov ali niste gotovi glede konstrukcije stene, se o montaži posvetujte s strokovnjakom.

EN.

WARNING! To prevent this furniture from tripping over, fix it to the wall permanently. The package includes fastening elements only suitable for concrete or full-brick walls. If your wall is made of a different material or you are unsure as to the construction of the wall, please consult a specialist regarding installation.

FR.

ATTENTION! Ce meuble doit être fixé en permanence au mur pour éviter les risques de chute. L'ensemble comprend des moyens de fixation adaptés uniquement aux murs de béton ou de brique. Si votre mur est fait d'un matériau différent ou si vous êtes incertain quant à la construction du mur, consultez un spécialiste.

HR.

NAPOMENA! Namještaj mora biti trajno pričvršćen za zid, kako bi se izbjegao rizik od njegova prevrtanja. U paketu se nalaze elementi za pričvršćivanje prikladni isključivo za betonske zidove ili punu ciglu. Ako je Vaš zid izrađen od drugog materijala ili niste sigurni od čega je napravljen Vaš zid, konzultirajte se sa stručnjakom u vezi sa montažom.

CZ.

POZOR! Nábytek je nutné pevně připevnit ke zdi, abychom se vyhnuli riziku spojenému s jeho převrnutím. V balíčku se nacházejí připevňující prvky vhodné výhradně do betonových zdí nebo zdí z plných cihel. Pokud jsou Vaše zdi zhotoveny z jiného materiálu nebo si nejste jejich konstrukcí jisti, konzultujte otázku montáže se specialistou.

CN.

注意！本家具需要固定在墙上以免倒塌。本包所含有的固定部件仅适用于混凝土墙及整砖墙。欲使用在其他墙体或不确定墙体时，请向专家询问安装方式。

D.

ACHTUNG! Um alle mit dem Umkippen des Möbels verbundenen Risiken auszuschließen, muss das Möbel fest an der Wand verankert werden. Die im Paket enthaltenen Beschläge für die Wandbefestigung sind ausschließlich für Wände aus Beton oder Vollziegeln geeignet. Sollten die heimischen Wände aus anderem Baumaterial bestehen oder sollte es Zweifel in Hinsicht auf dieses Baumaterial geben, bitte eine Fachkraft zu Rate ziehen.

HU.

FIGYELEM! Rögzítse a bútorokat a falhoz, hogy elkerülje a bútor felborulásának kockázatát. A készletben kizárólag beton- vagy téglafalhoz használható kötőelemek találhatók. Ha a fal más anyagból készült, vagy ha nem tudja, milyen falak találhatók otthonában, forduljon szakemberhez.

SK.

POZOR! Nábytok musí byť trvalo pripevnený k stene tak, aby sa zamedzilo riziku prevrátenia. V balíku sa nachádzajú upevňovacie komponenty výlučne pre betónové steny alebo steny z plnej tehly. Ak je Vaša stena z iného materiálu alebo ak si nie ste istí, z čoho je stena vyhotovená, vyžiadajte si odbornú pomoc.

E.

¡ATENCIÓN! El mueble debe ser fijado permanentemente a la pared para evitar el riesgo relacionado con el vuelco del mueble. En el paquete hay elementos de fijación adecuados solo para paredes de hormigón o de ladrillo entero. Si su pared está hecha de otro material o no está seguro sobre la construcción de esta pared, consulte el montaje con un especialista.



Dekort® furniture is distinguished by original design and high quality of workmanship.  
This emblem confirms the originality of the purchased furniture.

Meble Dekort® wyróżniają się oryginalnym wzornictwem i wysoką jakością wykonania.  
Emblemat ten potwierdza oryginalność zakupionych mebli.

